



RF Power Field-Effect Transistors

N-Channel Enhancement-Mode Lateral MOSFETs

Designed for broadband commercial and industrial applications with frequencies from 470 to 860 MHz. The high gain and broadband performance of these devices make them ideal for large-signal, common source amplifier applications in 32 volt digital television transmitter equipment.

- Typical Broadband DVBT OFDM Performance @ 470-860 MHz, 32 Volts, $I_{DQ} = 2000$ mA, 8K Mode, 64 QAM
 Output Power — 45 Watts Avg.
 Power Gain ≥ 16.7 dB
 Drain Efficiency $\geq 21\%$
 ACPR ≤ -58 dBc
- Typical Broadband ATSC 8VSB Performance @ 470-860 MHz, 32 Volts, $I_{DQ} = 2000$ mA
 Output Power — 80 Watts Avg.
 Power Gain ≥ 16.5 dB
 Drain Efficiency $\geq 27.5\%$
 IMD ≤ -31.3 dBc
- Capable of Handling 10:1 VSWR, @ 32 Vdc, 860 MHz, 45 Watts CW Output Power

Features

- Characterized with Series Equivalent Large-Signal Impedance Parameters
- Internally Matched for Ease of Use
- Device Designed for Push-Pull Operation Only
- Integrated ESD Protection
- Excellent Thermal Stability
- Lower Thermal Resistance Package
- Low Gold Plating Thickness on Leads, 40 μ ” Nominal.
- RoHS Compliant
- In Tape and Reel. R3 Suffix = 250 Units per 56 mm, 13 inch Reel.
 R5 Suffix = 50 Units per 56 mm, 13 inch Reel.

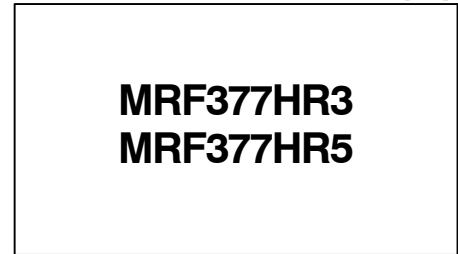

470 - 860 MHz, 45 W AVG., 32 V
 LATERAL N-CHANNEL
 RF POWER MOSFETs

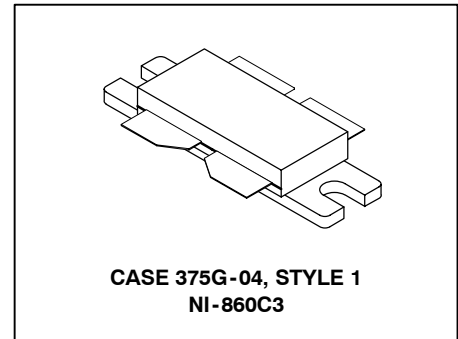

Table 1. Maximum Ratings

Rating	Symbol	Value	Unit
Drain-Source Voltage	V_{DSS}	- 0.5, +65	Vdc
Gate-Source Voltage	V_{GS}	- 0.5, +15	Vdc
Drain Current - Continuous	I_D	17	Adc
Total Device Dissipation @ $T_C = 25^\circ\text{C}$ Derate above 25°C	P_D	648 3.7	W W/ $^\circ\text{C}$
Storage Temperature Range	T_{stg}	- 65 to +150	$^\circ\text{C}$
Case Operating Temperature	T_C	150	$^\circ\text{C}$
Operating Junction Temperature	T_J	200	$^\circ\text{C}$
CW Operation @ $T_C = 25^\circ\text{C}$ Derate above 25°C	CW	235 1.38	W W/ $^\circ\text{C}$

Table 2. Thermal Characteristics

Characteristic	Symbol	Value (1,2)	Unit
Thermal Resistance, Junction to Case Case Temperature 81°C , 105 W CW Case Temperature 77°C , 45 W CW	$R_{\theta JC}$	0.27 0.29	$^\circ\text{C}/\text{W}$

1. MTTF calculator available at <http://www.freescale.com/rf>. Select Tools/Software/Application Software/Calculators to access the MTTF calculators by product.
2. Refer to AN1955, Thermal Measurement Methodology of RF Power Amplifiers. Go to <http://www.freescale.com/rf>. Select Documentation/Application Notes - AN1955.

Table 3. ESD Protection Characteristics

Test Conditions	Class
Human Body Model	1 (Minimum)
Machine Model	M3 (Minimum)
Charge Device Model	7 (Minimum)

Table 4. Electrical Characteristics ($T_C = 25^\circ\text{C}$ unless otherwise noted)

Characteristic	Symbol	Min	Typ	Max	Unit
Off Characteristics ⁽¹⁾					
Drain-Source Breakdown Voltage ⁽⁴⁾ ($V_{GS} = 0 \text{ Vdc}$, $I_D = 10 \mu\text{A}$)	$V_{(BR)DSS}$	65	—	—	Vdc
Zero Gate Voltage Drain Current ⁽⁴⁾ ($V_{DS} = 32 \text{ Vdc}$, $V_{GS} = 0 \text{ Vdc}$)	I_{DSS}	—	—	1	μAdc
Gate-Source Leakage Current ($V_{GS} = 5 \text{ Vdc}$, $V_{DS} = 0 \text{ Vdc}$)	I_{GSS}	—	—	1	μAdc
Gate Threshold Voltage ($V_{DS} = 10 \text{ Vdc}$, $I_D = 200 \mu\text{A}$)	$V_{GS(th)}$	—	2.8	—	Vdc

On Characteristics

Gate Quiescent Voltage ⁽³⁾ ($V_{DS} = 32 \text{ Vdc}$, $I_D = 2000 \text{ mAdc}$)	$V_{GS(Q)}$	2.5	3.5	4.5	Vdc
Drain-Source On-Voltage ⁽¹⁾ ($V_{GS} = 10 \text{ Vdc}$, $I_D = 3 \text{ A}$)	$V_{DS(on)}$	—	0.27	—	Vdc

Dynamic Characteristics ^(1,2)

Reverse Transfer Capacitance ($V_{DS} = 28 \text{ Vdc}$, $V_{GS} = 0$, $f = 1 \text{ MHz}$)	C_{rss}	—	3.2	—	pF
--	-----------	---	-----	---	----

Functional Tests ⁽³⁾ (In DVBT OFDM Single-Channel, Narrowband Fixture, 50 ohm system)

Common Source Power Gain ($V_{DD} = 32 \text{ Vdc}$, $P_{out} = 45 \text{ W Avg.}$, $I_{DQ} = 2000 \text{ mA}$, $f = 860 \text{ MHz}$)	G_{ps}	16.5	18.2	—	dB
Drain Efficiency ($V_{DD} = 32 \text{ Vdc}$, $P_{out} = 45 \text{ W Avg.}$, $I_{DQ} = 2000 \text{ mA}$, $f = 860 \text{ MHz}$)	η_D	21	22.9	—	%
Adjacent Channel Power Ratio ($V_{DD} = 32 \text{ Vdc}$, $P_{out} = 45 \text{ W Avg.}$, $I_{DQ} = 2000 \text{ mA}$, $f = 860 \text{ MHz}$)	ACPR	—	-59.2	-57	dBc

Typical Performances ⁽³⁾ (In DVBT OFDM Single-Channel, Broadband Fixture, 50 ohm system)

Common Source Power Gain ($V_{DD} = 32 \text{ Vdc}$, $P_{out} = 45 \text{ W Avg.}$, $I_{DQ} = 2000 \text{ mA}$)	G_{ps}				dB
$f = 470 \text{ MHz}$		—	17.6	—	
$f = 560 \text{ MHz}$		—	17.6	—	
$f = 660 \text{ MHz}$		—	17.4	—	
$f = 760 \text{ MHz}$		—	17.4	—	
$f = 860 \text{ MHz}$		—	16.8	—	

1. Each side of device measured separately.
2. Part is internally matched both on input and output.
3. Measurement made with device in push-pull configuration.
4. Drains are tied together internally as this is a total device value.

(continued)

Table 4. Electrical Characteristics ($T_C = 25^\circ\text{C}$ unless otherwise noted) (continued)

Characteristic	Symbol	Min	Typ	Max	Unit
Drain Efficiency ($V_{DD} = 32\text{ Vdc}$, $P_{out} = 45\text{ W Avg.}$, $I_{DQ} = 2000\text{ mA}$)	η_D				%
f = 470 MHz		—	23.5	—	
f = 560 MHz		—	25.8	—	
f = 660 MHz		—	23.0	—	
f = 760 MHz		—	22.7	—	
f = 860 MHz		—	21.3	—	
Adjacent Channel Power Ratio ($V_{DD} = 32\text{ Vdc}$, $P_{out} = 45\text{ W Avg.}$, $I_{DQ} = 2000\text{ mA}$)	ACPR				dBc
f = 470 MHz		—	-59.3	—	
f = 560 MHz		—	-59.3	—	
f = 660 MHz		—	-58.7	—	
f = 760 MHz		—	-58.7	—	
f = 860 MHz		—	-58.1	—	

Typical Performances ⁽¹⁾ (In ATSC 8VSB Single-Channel, Broadband Fixture, 50 ohm system)

Common Source Power Gain ($V_{DD} = 32\text{ Vdc}$, $P_{out} = 80\text{ W Avg.}$, $I_{DQ} = 2000\text{ mA}$)	G_{ps}				dB
f = 470 MHz		—	17.5	—	
f = 560 MHz		—	17.5	—	
f = 660 MHz		—	17.2	—	
f = 760 MHz		—	17.2	—	
f = 860 MHz		—	16.6	—	
Drain Efficiency ($V_{DD} = 32\text{ Vdc}$, $P_{out} = 80\text{ W Avg.}$, $I_{DQ} = 2000\text{ mA}$)	η_D				%
f = 470 MHz		—	31.0	—	
f = 560 MHz		—	34.3	—	
f = 660 MHz		—	30.1	—	
f = 760 MHz		—	29.6	—	
f = 860 MHz		—	27.8	—	
Intermodulation Distortion ($V_{DD} = 32\text{ Vdc}$, $P_{out} = 80\text{ W Avg.}$, $I_{DQ} = 2000\text{ mA}$)	IMD				dBc
f = 470 MHz		—	31.7	—	
f = 560 MHz		—	32.7	—	
f = 660 MHz		—	32.9	—	
f = 760 MHz		—	34.2	—	
f = 860 MHz		—	35.4	—	

1. Measurement made with device in push-pull configuration.

Table 5. 845-875 MHz Narrowband Test Circuit Component Designations and Values

Part	Description	Part Number	Manufacturer
B1, B2	Ferrite Beads, Surface Mount, 11 Ω (0805)	2508051107Y0	Fair-Rite
Balun 1, Balun 2	0.8-1GHz Xinger Balun	3A412	Anaran
C1	33 pF Chip Capacitor (0805)	08055J330JBT	AVX / Kyocera
C2	2.7 pF Chip Capacitor (0603)	06035J2R7BBT	AVX / Kyocera
C3	12 pF Chip Capacitor (0805)	08051J120GBT	AVX / Kyocera
C4, C5	6.8 pF Chip Capacitors (0805)	08051J6R8BBT	AVX / Kyocera
C6	2.7 pF Chip Capacitor (0805)	0805J2R7BBT	AVX / Kyocera
C7, C8, C9, C10	3.3 pF Chip Capacitors (0805)	08051J3R3BBT	AVX / Kyocera
C11, C12	2.2 μ F, 50 V Chip Capacitors	C1825C225J5RAC3810	Kemet
C13, C14, C15, C16	0.01 μ F, 100 V Chip Capacitors	C1825C103J1GAC	Kemet
C17, C18	0.56 μ F, 50 V Chip Capacitors	C1825C564J5RAC	Kemet
C19, C20	10 μ F, 50 V Tantalum Chip Capacitors	522Z050/100MTRE	Tecate
C21, C22, C23, C24	47 μ F, 16 V Tantalum Chip Capacitors	TPSD476K016R0150	AVX / Kyocera
C25, C26	470 μ F, 63 V Electrolytic Capacitors	NACZF471M63V (18x22)	Nippon
L1	12 nH Inductor (0603)	0603HC-12NXJB	CoilCraft
L2	7.15 nH Inductor	1606-7	CoilCraft
L3, L4	10 nH Inductor (0603)	0603HC-10NXJB	CoilCraft
R1, R2	24 Ω , 1/8 W, 5% Chip Resistors (1206)		
WB1, WB2, WB3, WB4	Brass Wear Shims		
PCB	Arlon 30 mil, $\epsilon_r = 2.56$	DS1152	DS Electronics

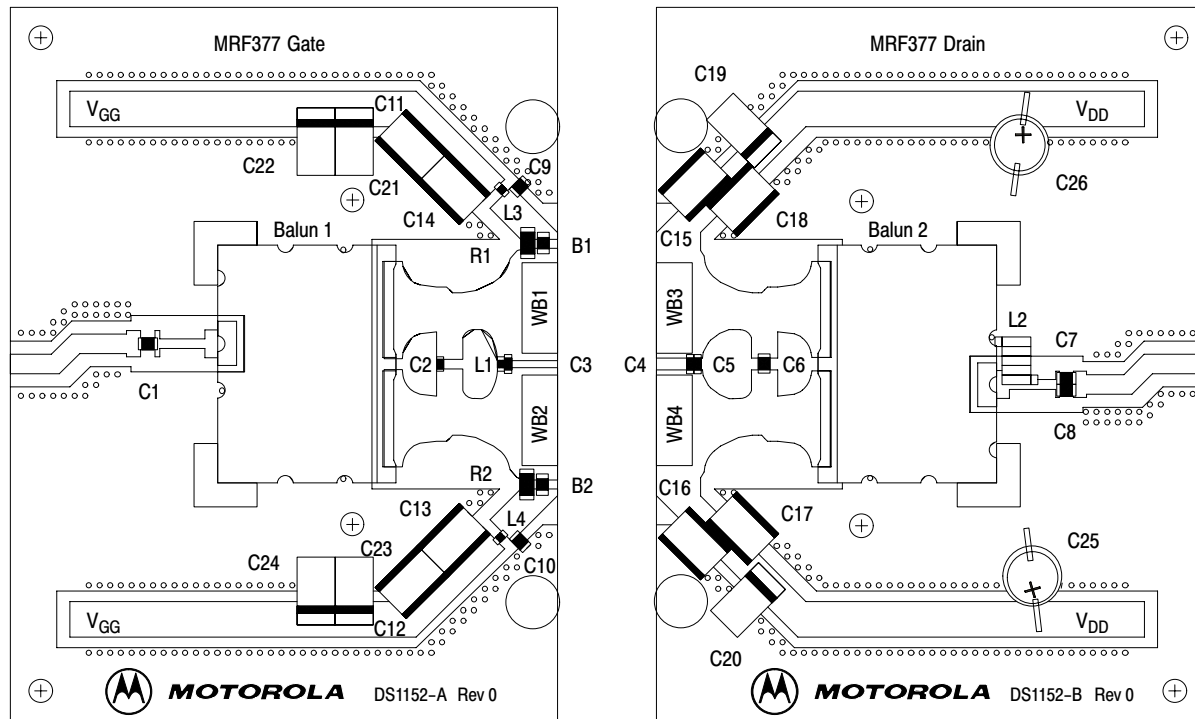

Freescale has begun the transition of marking Printed Circuit Boards (PCBs) with the Freescale Semiconductor signature/logo. PCBs may have either Motorola or Freescale markings during the transition period. These changes will have no impact on form, fit or function of the current product.

Figure 1. 845-875 MHz Narrowband Test Circuit Component Layout

TYPICAL NARROWBAND CHARACTERISTICS

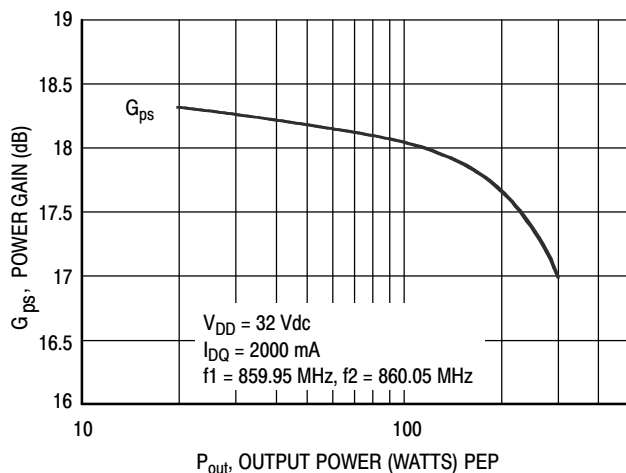

Figure 2. Two-Tone Power Gain versus Output Power

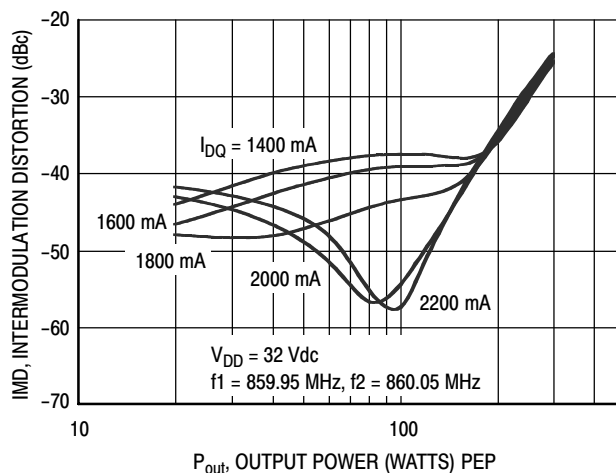

Figure 3. Third Order Intermodulation Distortion versus Output Power

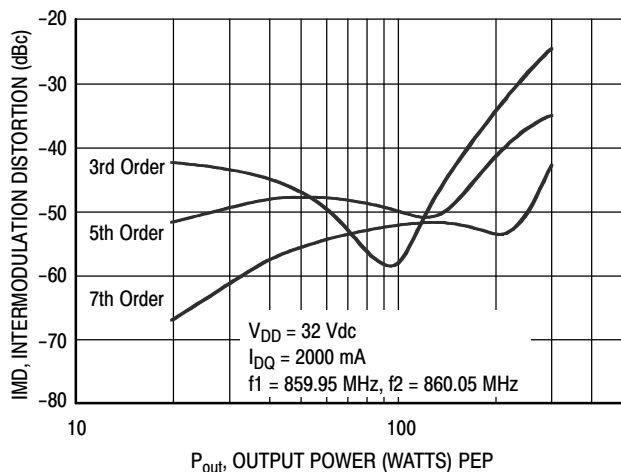

Figure 4. Intermodulation Distortion Products versus Output Power

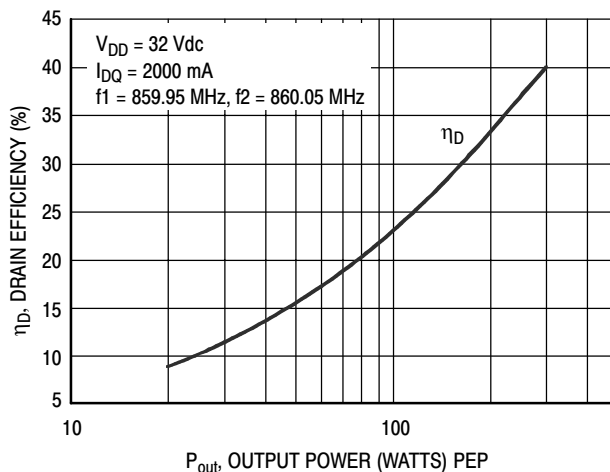

Figure 5. Two-Tone Drain Efficiency versus Output Power

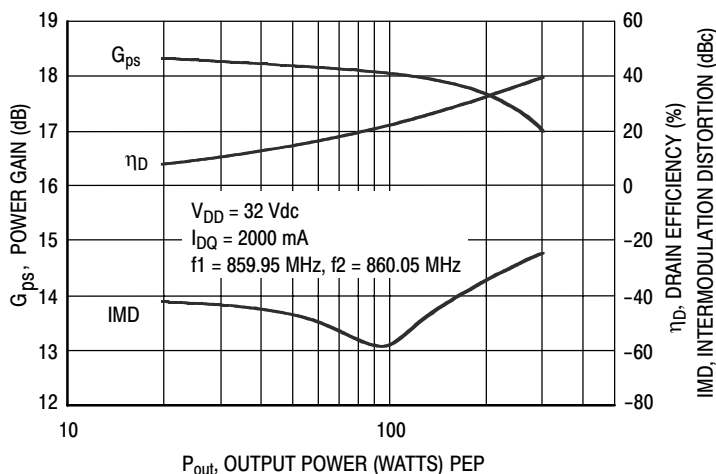
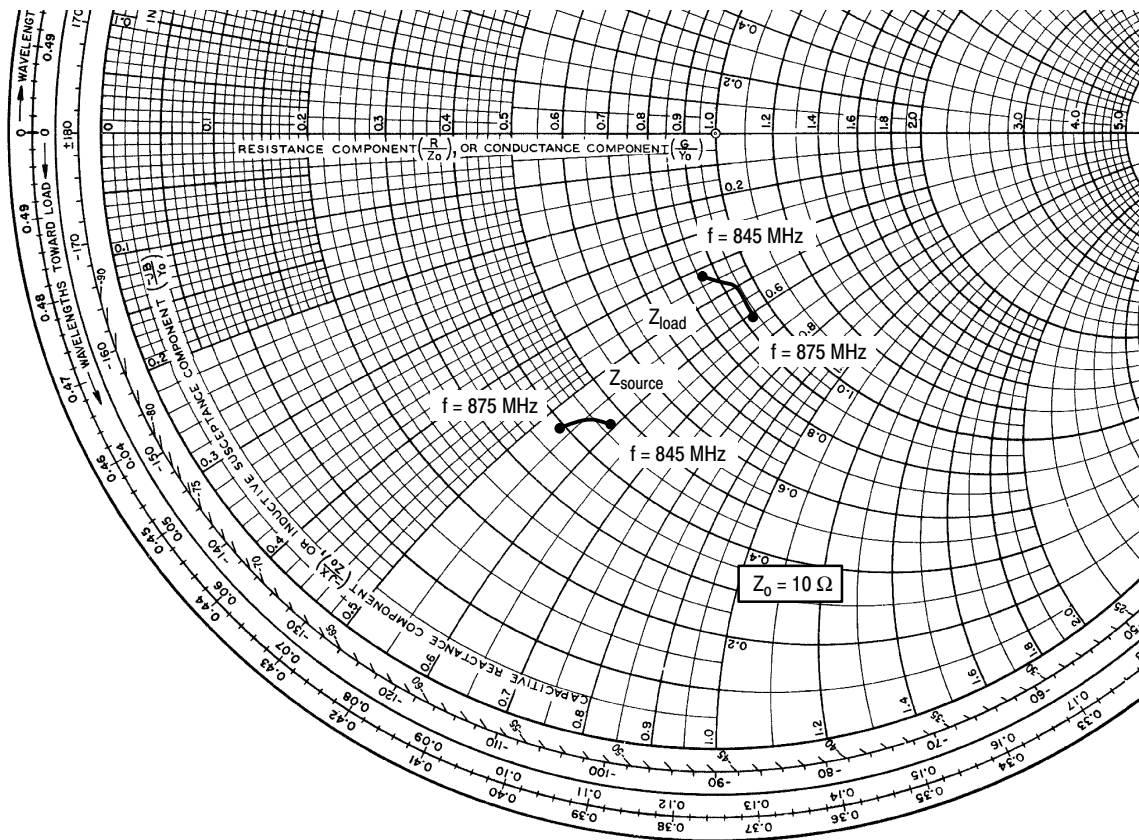

Figure 6. Power Gain, Efficiency and IMD versus Output Power



$V_{DD} = 32\text{ V}$, $I_{DQ} = 2000\text{ mA}$, $P_{out} = 45\text{ W Avg.}$, DVBT OFDM

f MHz	Z_{source} Ω	Z_{load} Ω
845	$4.66 - j5.90$	$8.59 - j4.22$
860	$4.38 - j5.64$	$9.36 - j4.95$
875	$3.93 - j5.33$	$9.39 - j6.06$

Z_{source} = Test circuit impedance as measured from gate to gate, balanced configuration.

Z_{load} = Test circuit impedance as measured from drain to drain, balanced configuration.

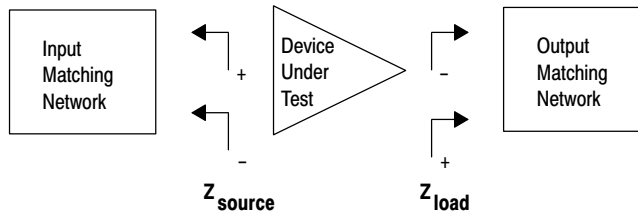
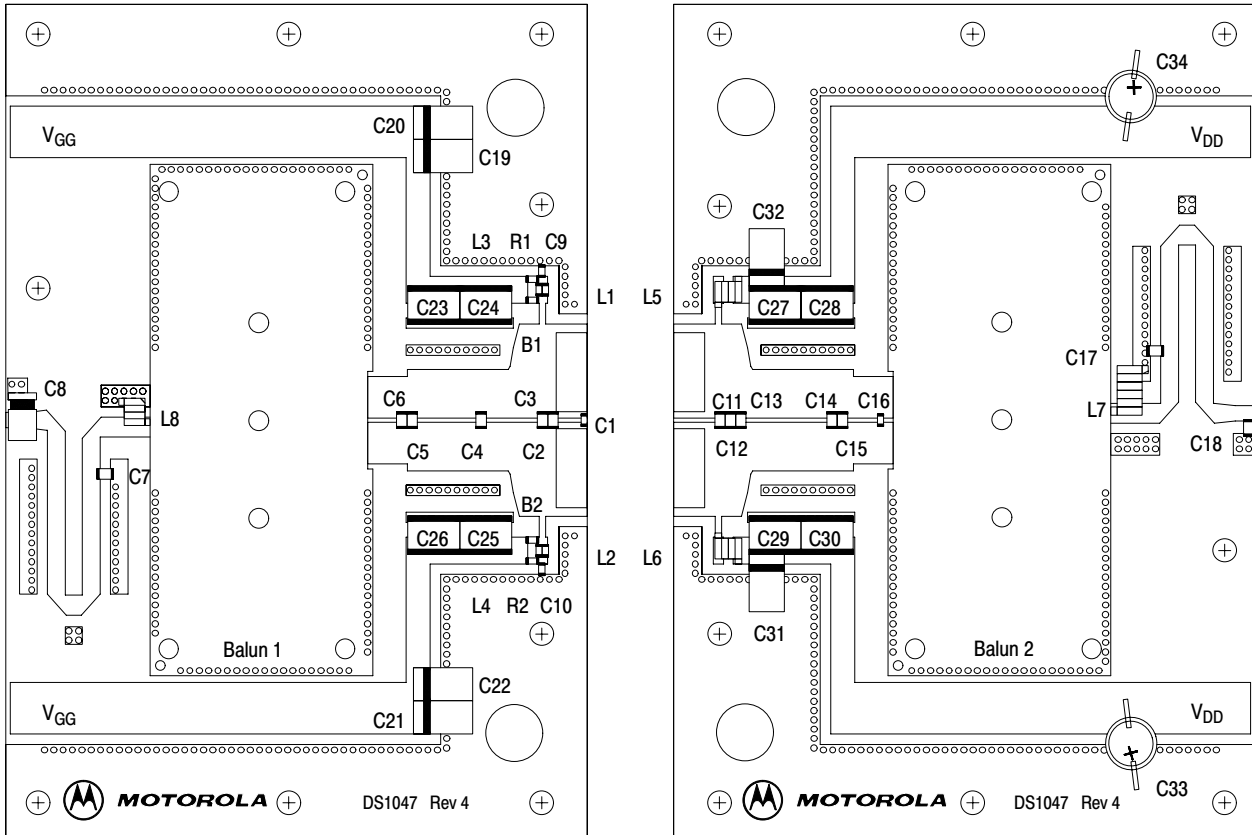

Figure 7. 845-875 MHz Narrowband Series Equivalent Source and Load Impedance

Table 6. 470—860 MHz Broadband Test Circuit Component Designations and Values

Part	Description	Part Number	Manufacturer
B1, B2	Ferrite Beads, Surface Mount, 30 Ω (0603)	2506033007Y0	Fair-Rite
Balun 1, Balun 2	Rogers 3.006, $\epsilon_r = 6.06$, 1 oz Cu	DS1046	DS Electronics
C1	12 pF Chip Capacitor (0603)	06035J120GBT	AVX / Kyocera
C2, C5	12 pF Chip Capacitors (0805)	08051J120GBT	AVX / Kyocera
C3	3.9 pF Chip Capacitor (0805)	08051J3R9BBT	AVX / Kyocera
C4, C7, C12, C15, C17	8.2 pF Chip Capacitors (0805)	08051J8R2BBT	AVX / Kyocera
C6	3.3 pF Chip Capacitor (0805)	08051J3R3BBT	AVX / Kyocera
C8	0.4 - 2.5 pF Variable Capacitor	27283PC	Gigatronics
C9, C10	3.3 pF Chip Capacitors (0603)	06035J3R3BBT	AVX / Kyocera
C11, C14	10 pF Chip Capacitor (0805)	08051J100GBT	AVX / Kyocera
C13	4.7 pF Chip Capacitor (0805)	08051J4R7BBT	AVX / Kyocera
C16	2.2 pF Chip Capacitor (0603)	06035J2R2BBT	AVX / Kyocera
C18	2.2 pF Chip Capacitor (0805)	08051J2R2BBT	AVX / Kyocera
C19, C20, C21, C22	47 μ F, 16 V Tantalum Chip Capacitors	TPSD476K016R0150	AVX
C23, C26	2.2 μ F, 50 V Ceramic Chip Capacitors	C1825C225J5RAC3810	Kemet
C24, C25, C27, C29	0.01 μ F, 100 V Ceramic Chip Capacitors	C1825C103J1GAC	Kemet
C28, C30	0.56 μ F, 50 V Ceramic Chip Capacitors	C1825C564J5GAC	Kemet
C31, C32	10 μ F, 50 V Chip Capacitors	522Z-050/100MTRE	Tecate
C33, C34	470 μ F, 63 V Electrolytic Capacitors	SME63VB471M12X25LL	United Chemi-Con
L1, L2	15 nH Inductors (0603)	L0603150GGW003	AVX
L3, L4	12 nH Inductors (0603)	0603HC-12NHJBU	CoilCraft
L5, L6	8 nH Coil Inductors	A03T-5	CoilCraft
L7	22 nH Coil Inductor	B07T-5	CoilCraft
L8	18.5 nH Coil Inductor	A05T-5	CoilCraft
R1, R2	12.1 Ω , 1/16 W, 1% Chip Resistors (0603)		
PCB Gate, PCB Drain	PCB Motherboard w/Integrated Daughterboard, Rogers 3003, $\epsilon_r = 3.03$, 0.5 oz Cu	DS1047	DS Electronics



Freescal has begun the transition of marking Printed Circuit Boards (PCBs) with the Freescale Semiconductor signature/logo. PCBs may have either Motorola or Freescale markings during the transition period. These changes will have no impact on form, fit or function of the current product.

Multilayer Balun Mounting Detail

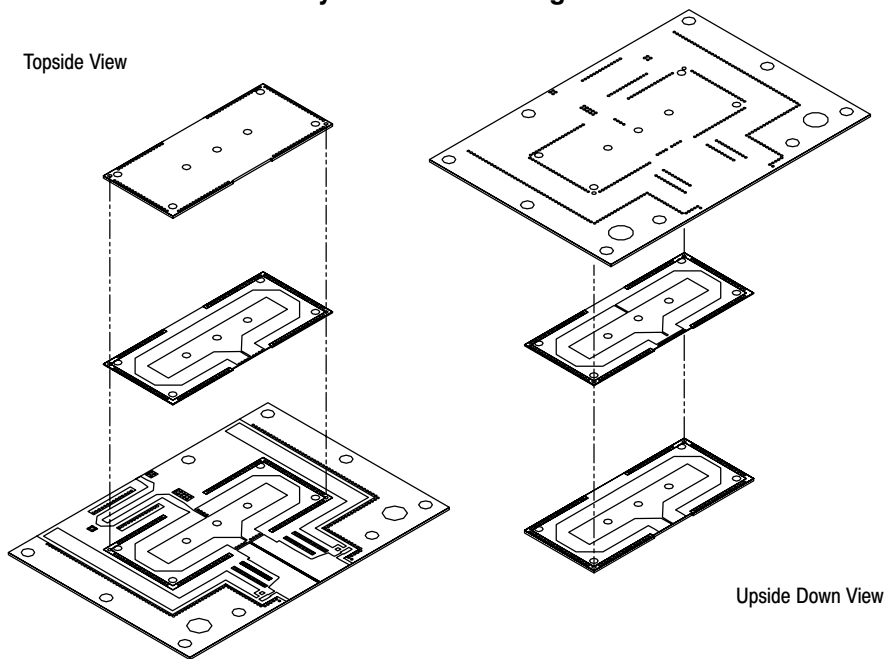

Figure 8. 470-860 MHz Broadband Test Circuit Component Layout

TYPICAL DVBT OFDM BROADBAND CHARACTERISTICS

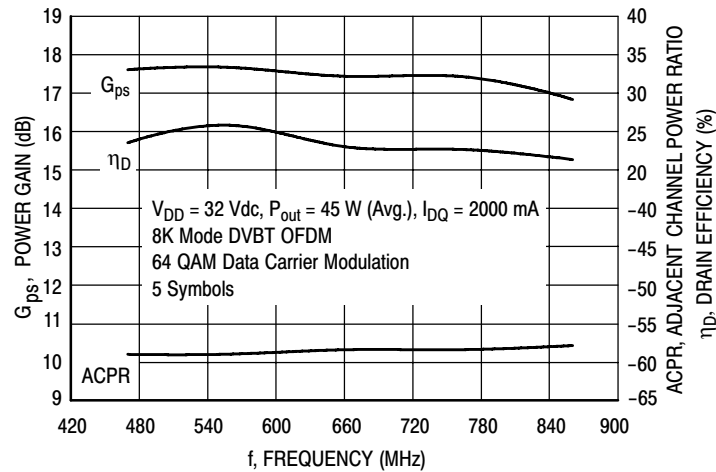

Figure 9. Single-Channel DVBT OFDM Broadband Performance

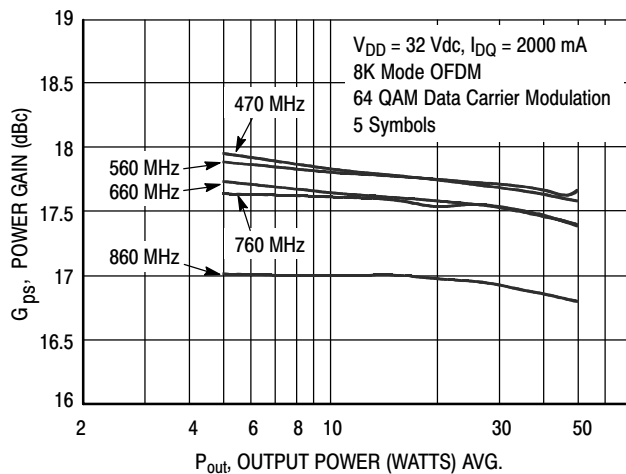

Figure 10. Single-Channel DVBT OFDM Broadband Performance Power Gain versus Output Power

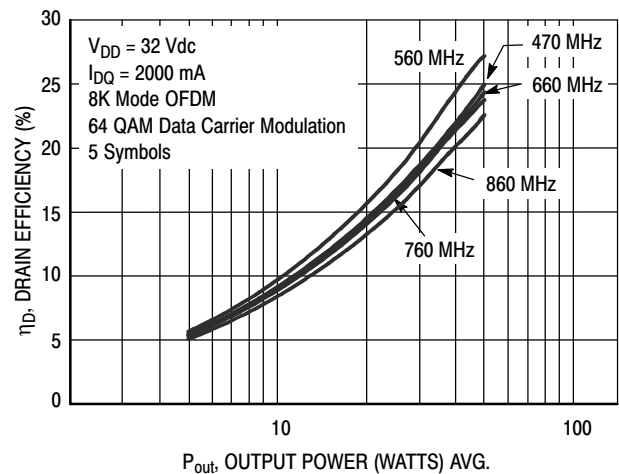

Figure 11. Single-Channel DVBT OFDM Broadband Performance Drain Efficiency versus Output Power

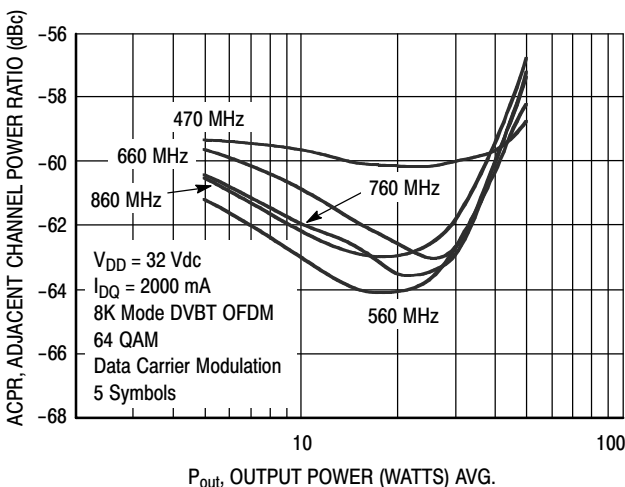

Figure 12. Single-Channel DVBT OFDM Broadband Performance Adjacent Channel Power Ratio versus Output Power

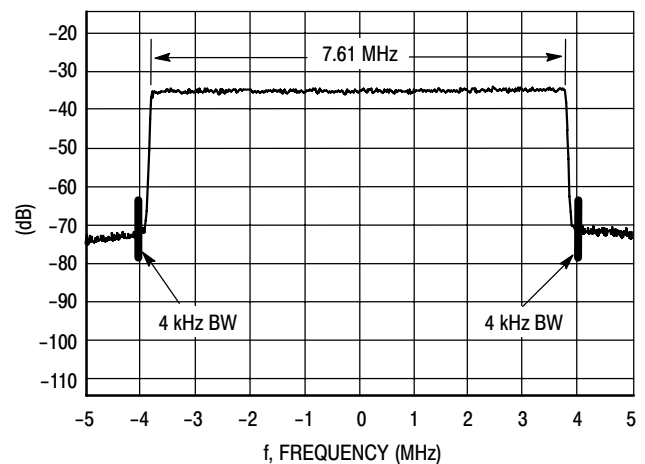

Figure 13. 8K Mode DVBT OFDM Spectrum

TYPICAL ATSC 8VSB BROADBAND CHARACTERISTICS

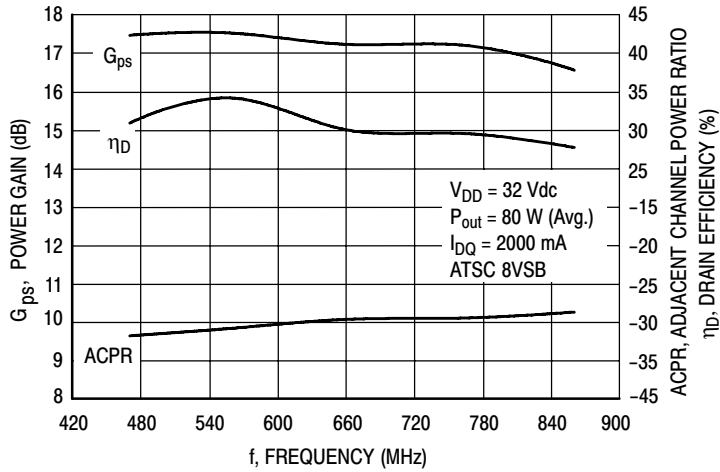

Figure 14. Single-Channel ATSC 8VSB Broadband Performance

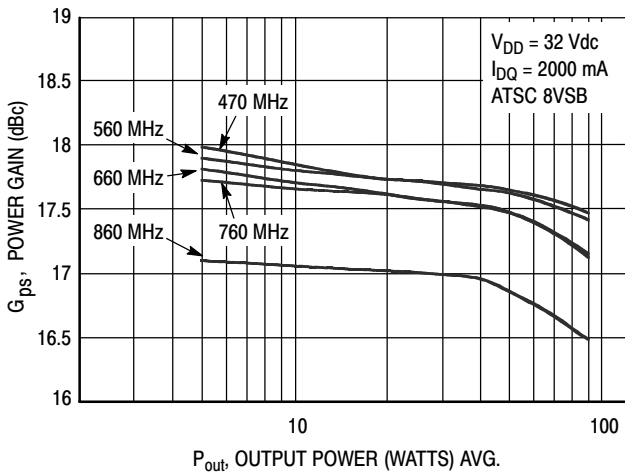

Figure 15. Single-Channel ATSC 8VSB Broadband Performance Power Gain versus Output Power

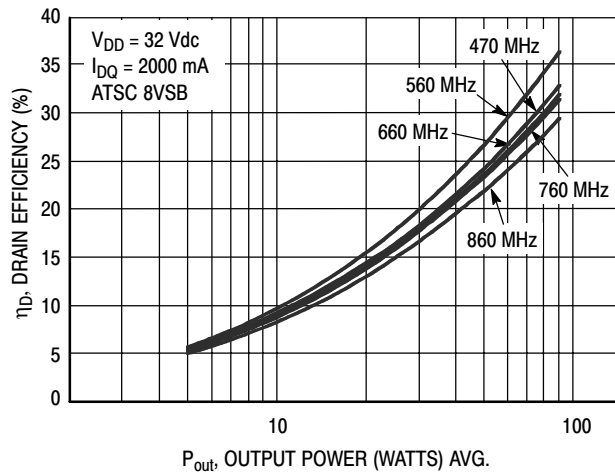

Figure 16. Single-Channel ATSC 8VSB Broadband Performance Drain Efficiency versus Output Power

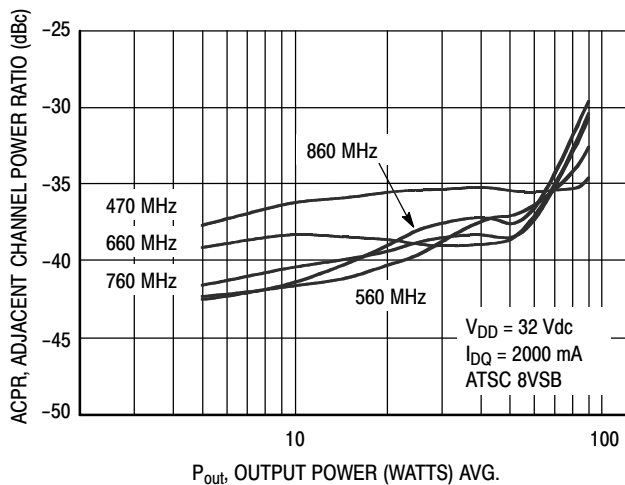

Figure 17. Single-Channel ATSC 8VSB Broadband Performance Adjacent Channel Power Ratio versus Output Power

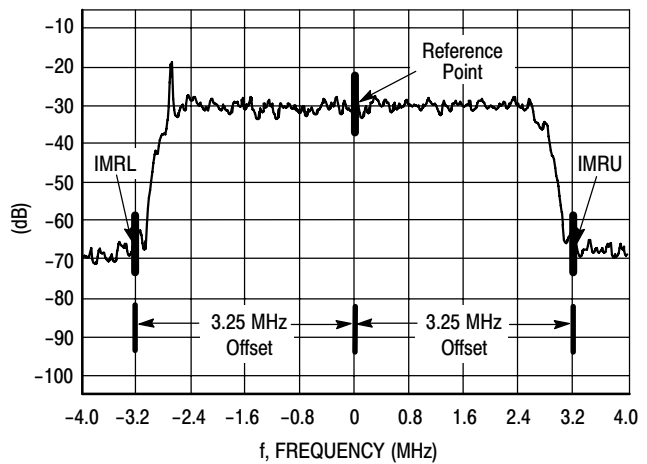
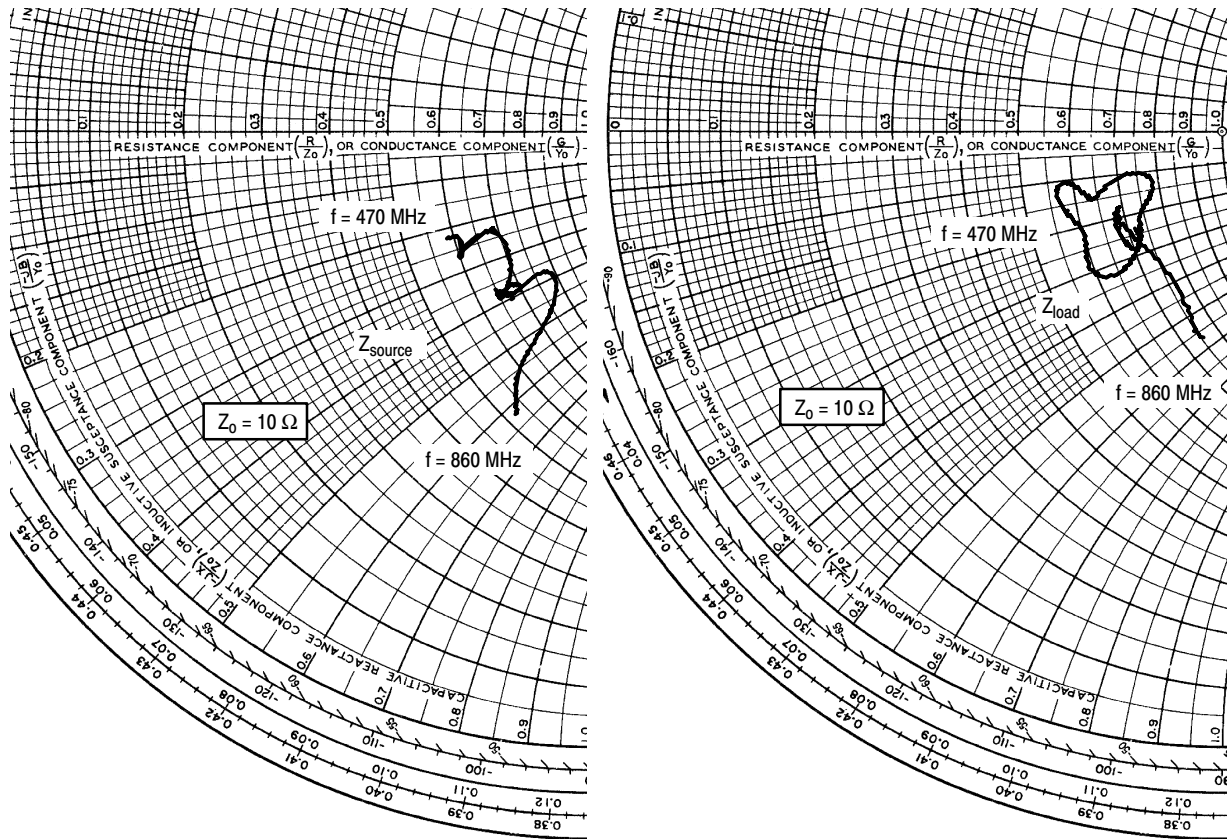

Figure 18. ATSC 8VSB Spectrum



Optimized for $V_{DD} = 32\text{ V}$, $I_{DQ} = 2000\text{ mA}$, $P_{out} = 45\text{ W Avg.}$, DVBT OFDM

f MHz	Z_{source} Ω	Z_{load} Ω
470	5.79 - j2.40	6.21 - j1.69
560	6.63 - j2.63	5.66 - j1.12
660	6.57 - j4.03	6.76 - j1.00
760	6.67 - j4.55	6.57 - j1.91
860	5.34 - j6.28	7.37 - j5.45

Z_{source} = Test circuit impedance as measured from gate to gate, balanced configuration.

Z_{load} = Test circuit impedance as measured from drain to drain, balanced configuration.

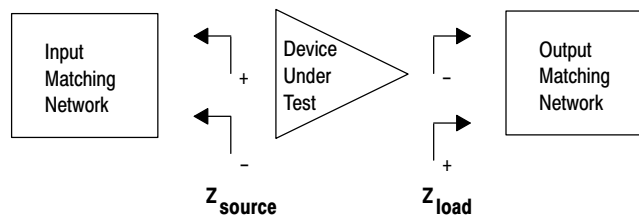

Figure 19. 470—860 MHz Broadband Series Equivalent Source and Load Impedance

NOTES

NOTES

NOTES

PACKAGE DIMENSIONS

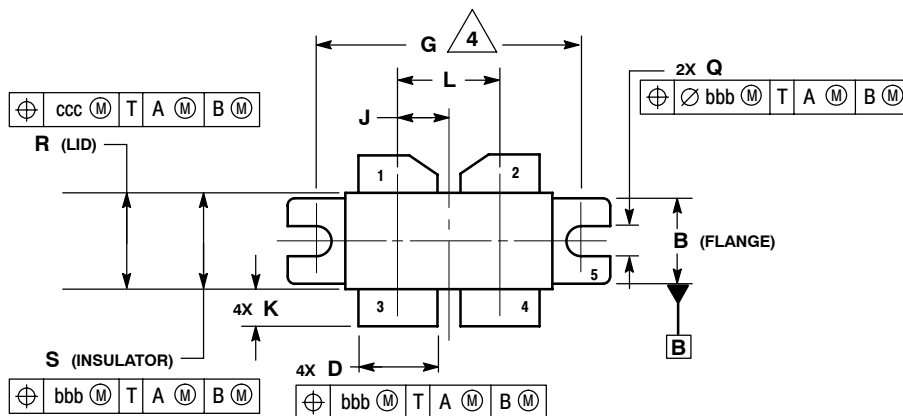

- NOTES:
1. CONTROLLING DIMENSION: INCH.
 2. INTERPRET DIMENSIONS AND TOLERANCES PER ASME Y14.5M-1994.
 3. DIMENSION H TO BE MEASURED 0.030 (0.762) AWAY FROM PACKAGE BODY.
 4. RECOMMENDED BOLT CENTER DIMENSION OF 1.140 (28.96) BASED ON 3M SCREW.

DIM	INCHES		MILLIMETERS	
	MIN	MAX	MIN	MAX
A	1.335	1.345	33.91	34.16
B	0.380	0.390	9.65	9.91
C	0.180	0.224	4.57	5.69
D	0.325	0.335	8.26	8.51
E	0.060	0.070	1.52	1.78
F	0.004	0.006	0.10	0.15
G	1.100 BSC		27.94 BSC	
H	0.097	0.107	2.46	2.72
J	0.2125 BSC		5.397 BSC	
K	0.135	0.165	3.43	4.19
L	0.425 BSC		10.8 BSC	
M	0.852	0.868	21.64	22.05
N	0.851	0.869	21.62	22.07
Q	0.118	0.138	3.00	3.30
R	0.395	0.405	10.03	10.29
S	0.394	0.406	10.01	10.31
bbb	0.010 REF		0.25 REF	
ccc	0.015 REF		0.38 REF	

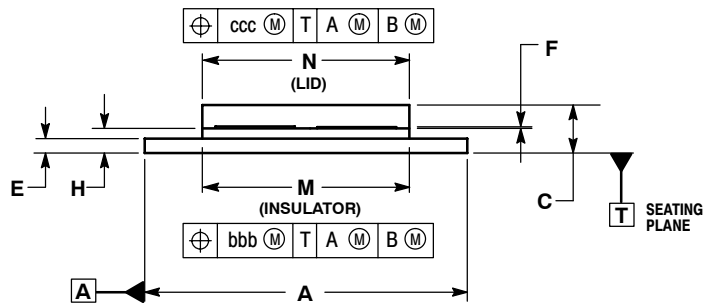

- STYLE 1:
 PIN 1. DRAIN
 2. DRAIN
 3. GATE
 4. GATE
 5. SOURCE

**CASE 375G-04
 ISSUE G
 NI-860C3**

How to Reach Us:

Home Page:
www.freescale.com

E-mail:
support@freescale.com

USA/Europe or Locations Not Listed:
Freescale Semiconductor
Technical Information Center, CH370
1300 N. Alma School Road
Chandler, Arizona 85224
+1-800-521-6274 or +1-480-768-2130
support@freescale.com

Europe, Middle East, and Africa:
Freescale Halbleiter Deutschland GmbH
Technical Information Center
Schatzbogen 7
81829 Muenchen, Germany
+44 1296 380 456 (English)
+46 8 52200080 (English)
+49 89 92103 559 (German)
+33 1 69 35 48 48 (French)
support@freescale.com

Japan:
Freescale Semiconductor Japan Ltd.
Headquarters
ARCO Tower 15F
1-8-1, Shimo-Meguro, Meguro-ku,
Tokyo 153-0064
Japan
0120 191014 or +81 3 5437 9125
support.japan@freescale.com

Asia/Pacific:
Freescale Semiconductor Hong Kong Ltd.
Technical Information Center
2 Dai King Street
Tai Po Industrial Estate
Tai Po, N.T., Hong Kong
+800 2666 8080
support.asia@freescale.com

For Literature Requests Only:
Freescale Semiconductor Literature Distribution Center
P.O. Box 5405
Denver, Colorado 80217
1-800-441-2447 or 303-675-2140
Fax: 303-675-2150
LDCForFreescaleSemiconductor@hibbertgroup.com

Information in this document is provided solely to enable system and software implementers to use Freescale Semiconductor products. There are no express or implied copyright licenses granted hereunder to design or fabricate any integrated circuits or integrated circuits based on the information in this document.

Freescale Semiconductor reserves the right to make changes without further notice to any products herein. Freescale Semiconductor makes no warranty, representation or guarantee regarding the suitability of its products for any particular purpose, nor does Freescale Semiconductor assume any liability arising out of the application or use of any product or circuit, and specifically disclaims any and all liability, including without limitation consequential or incidental damages. "Typical" parameters that may be provided in Freescale Semiconductor data sheets and/or specifications can and do vary in different applications and actual performance may vary over time. All operating parameters, including "Typicals", must be validated for each customer application by customer's technical experts. Freescale Semiconductor does not convey any license under its patent rights nor the rights of others. Freescale Semiconductor products are not designed, intended, or authorized for use as components in systems intended for surgical implant into the body, or other applications intended to support or sustain life, or for any other application in which the failure of the Freescale Semiconductor product could create a situation where personal injury or death may occur. Should Buyer purchase or use Freescale Semiconductor products for any such unintended or unauthorized application, Buyer shall indemnify and hold Freescale Semiconductor and its officers, employees, subsidiaries, affiliates, and distributors harmless against all claims, costs, damages, and expenses, and reasonable attorney fees arising out of, directly or indirectly, any claim of personal injury or death associated with such unintended or unauthorized use, even if such claim alleges that Freescale Semiconductor was negligent regarding the design or manufacture of the part.

Freescale™ and the Freescale logo are trademarks of Freescale Semiconductor, Inc. All other product or service names are the property of their respective owners.
© Freescale Semiconductor, Inc. 2006. All rights reserved.

